

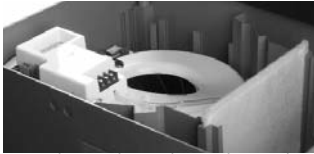

Technical Support Dept. T. 02920 858585 F. 02920 858586

ES-MEV - Hints & Tips



I.O. On Installation

Follow the installation and maintenance document 671266 for ES-MEV, paying particular attention to:

I.1. The chosen location for installation.

- Mounting the unit using the integral mounting bracket supplied.
- Mount the unit on a non reverberant surface.
- The unit can be mounted at any angle.
- Make sure that when the unit is mounted sufficient space is left around the unit for maintenance and the fixing of the ducting.

- If installed with flexible duct special care/ consideration should be made to prevent the duct being closed off, cracked or twisted, introducing a high resistance on the system.

I.2. Electrical.

- Pay particular attention to electrical connections referring to the I&M for correct method.
- Isolation of the unit and any switched live circuits should be achieved through the same isolator.

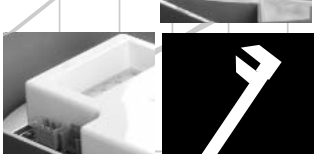
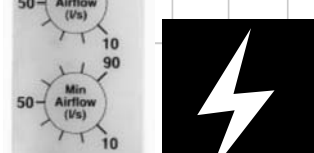
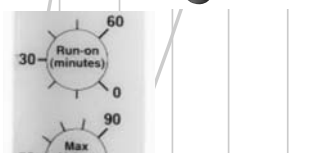
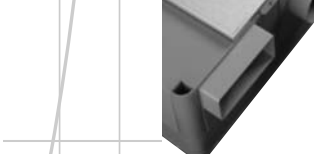
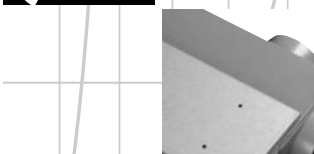
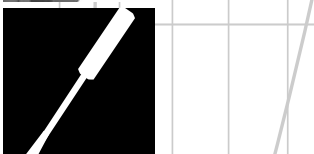
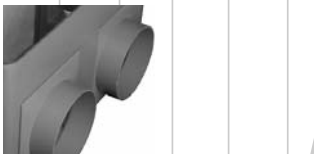

0.01



Circuit board connections.

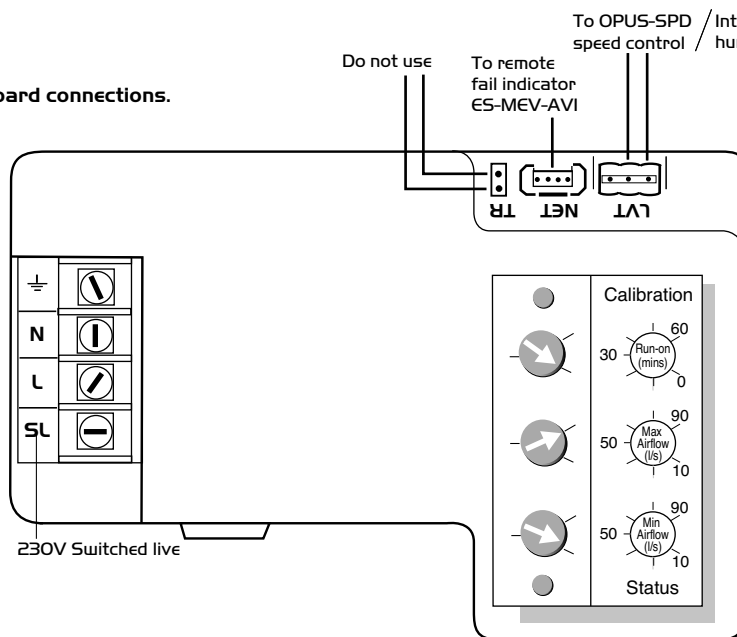

I.3 Setting to work

When initially powered the ES-MEV will self calibrate, it will try to achieve the duties set by the MAX and MIN set points.

The calibration process can take around 2 minutes and is as follows:

- Unit runs to full speed. (Faster than the max set point).
- The unit will slow down and eventually stop.
- A 10 second wait.
- It will restart and run at ¼ speed.
- The unit then settles to the MIN speed.

If, during this process the red LED should illuminate, ensure there are no switched live or boost signals present.

Upon completion of the calibration process apply a switched live (SL), the fan speed and duty should increase to that of the MAX set point.

When testing a system

- The 'dial a duty' set points should be positioned with the MAX at MAX and MIN at MIN, i.e. giving the widest possible speed control range.
- On an existing installation it is important to observe and note these duty positions should it be necessary to return to them later.

- The SL run on should be set to minimum to reduce the run on time during test, it is important to note the position set should it be necessary to return to it later.

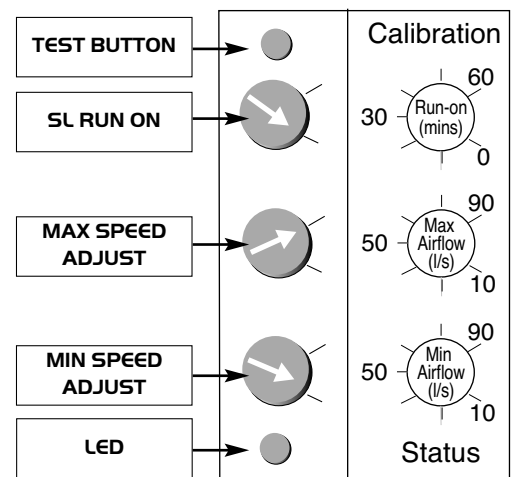

continued overleaf.



ES-MEV - Hints & Tips

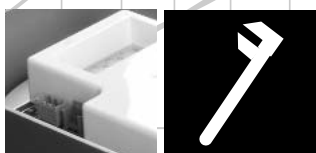
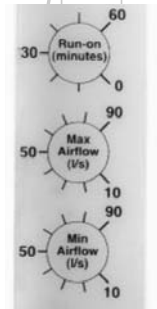
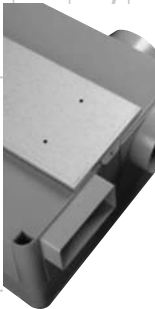
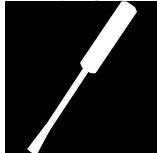
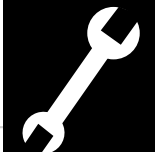
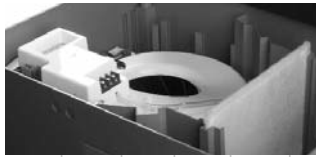

0.01

2.0 On Maintenance

- 2.1 Motors contain sealed for life bearings, no lubrication is necessary.
- 2.2 A washable filter is fitted, we recommended that all unit filters are inspected and cleaned (wash in light detergent and dry before refitting) after the first six months and determine the maintenance frequency there after by the rate and type of contamination.
- 2.3 Lightly brush excess dirt from unit cases and fan impellers taking care not to disturb impeller balance weights – if washing is necessary apply a light detergent and dry.

3.0 On Spares

Should a defect arise during installation or 'setting to work' of the unit. Firstly isolate the unit and re apply the power after 10 seconds. Check all wiring

is correct and no boost signal is present. If a fault still exists, in the first instance please call our technical department on 029 2085 8585. The internal parts are exchangeable and can be removed as a whole component or if necessary it is possible to replace the main PCB.

Component Spares	Part No.
Complete internal fan/control assembly	774941-P
Dial a duty PCB	830178
Filter	070784

4.0 Trouble Shooting

Complaints are generally that the unit is 'not working' so it will be first necessary to distinguish between an electrical/mechanical malfunction or whether the unit operates but simply fails to extract air. (see table below for possible problems and corrective procedures).

Complaint	Cause and correct	Complaint	Cause and correct
Not powering up.	Ensure mains power to unit. The green LED should flash. Ensure unit hasn't been switched off or isolated and that the local fuse hasn't blown.	Red LED flashing 6 times after start up procedure has finished. Red LED flashing 7 times after start up procedure has finished.	Fan is unable to achieve the duty required. Excessive system pressure. Adjust set point and press the calibrate button. Check for blocked/crushed ductwork, closed air valves, blocked external air bricks/grilles etc. Ensure pressure pipe from the blower is correctly attached to the pressure switch. Motor failure - replace internals
Not working would usually suggest that it has at sometime functioned correctly.	Ensure unit hasn't been switched off or that the local fuse hasn't blown. LED flash but fan doesn't run signifies a motor failure, replace the fan internal. If electricity present, power off, wait and power on again – this may restart the unit.	High airflow but no discharge to atmosphere.	Low system pressure: • Ensure all ducting is connected from fan to atmosphere.
Noise.	Impeller fouling case. Replace internal. Contaminated impeller causing an out of balance. Lightly brush away excess dirt taking care not to disturb balance weights. Unit not mounted on a flat surface causing distortion, adjust fixing. High system pressure, causing unit to run at high speed to obtain duty selected. (see right).	Low airflow but fan speed high.	High system pressure, check for: • Dirty filters • Backdraught shutters jammed shut • Blocked outlet grilles. • Long ducted runs • Twists, bends or crushed flexible duct work



5.0 ES-MEV Replacement of the 830178 PCB

5.1 The replacement of the PCB should be undertaken when the fault finding procedure has identified a problem in this area and cannot be rectified by re-adjustment of the duties required.

5.2. Isolate unit. (See unit Figure below).

Take note of the duties set as the unit may have been commissioned for air flow and will have to be reset once the PCB is replaced.

Remove Live, Neutral, Switched live and earth connections.

Remove the 2 'mate-n-lock' plugs that interconnect the PCB's.

Undo the central mounting screw and lift the PCB.

Remove the pressure pipe from the differential pressure sensor. (NB Use only the bottom spigotted inlet).

To replace, reverse the above procedure.

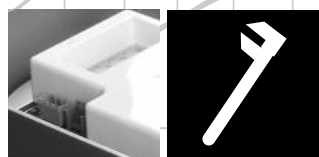
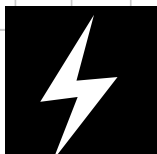
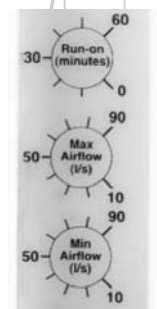
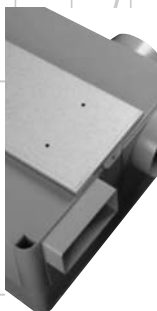
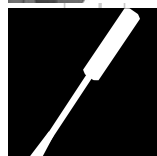
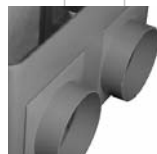
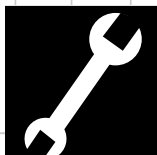
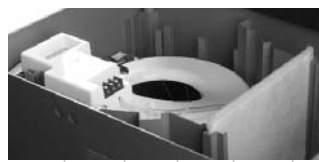

0.01

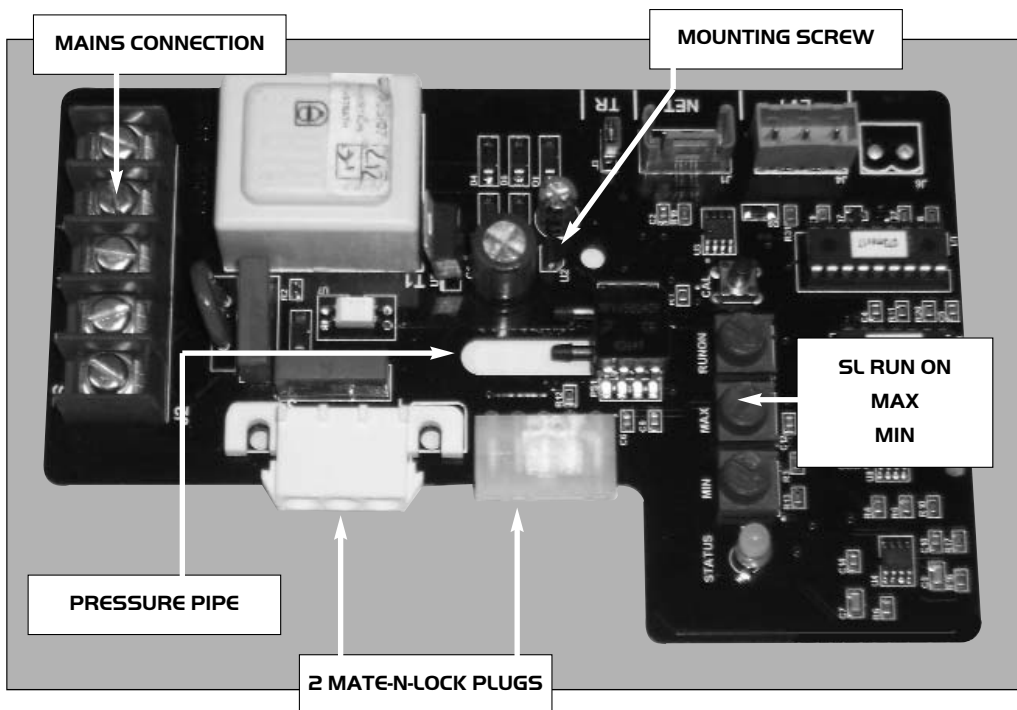

830178 PCB with protective cover removed.