

## EZPLATE FANS

TROUBLE FREE, ECONOMICAL SOLUTION FOR LARGE OPEN AREAS.



## BENEFITS

### TROUBLE FREE OPERATION

Tested and reliable rotor motors ensure long life and trouble free operation.

### ECONOMICAL OPTION

A range of controllers are available. All motors are speed controllable to ensure the most economical use.

### ENERGY EFFICIENT

Advanced sickle bladed or aerofoil, dynamically balanced technology provides an efficient and quiet operation.

### ADDED SAFETY

All motors are fitted with a 'heatseeker' thermal overload device which gives added safety.

### MAXIMUM FLEXIBILITY

Fans can be fitted in any altitude to give maximum flexibility on site.

### EASY TO INSTALL

Units have an integral terminal box and motor side guard (on sizes up to 710mm) for easy installation and safe operation.

### ADDED PROTECTION

All motors have a corrosion resistant coating and are IP44 rated (sizes 315-450), Class IP54 for all others.

### WARRANTY

EZplate has a 3 year warranty.

### ANCILLARIES FOR EZPLATE

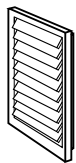

Outlet Shutter.

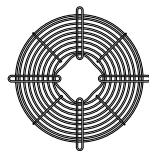

Inlet Finger Guard.



Inverter Speed Control.

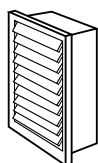

Wall Fixing Kit.

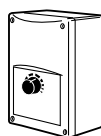

Electronic Speed Controls.

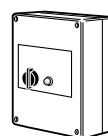

Transformer Speed Control.

### TYPICAL WALL MOUNTING INSTALLATION

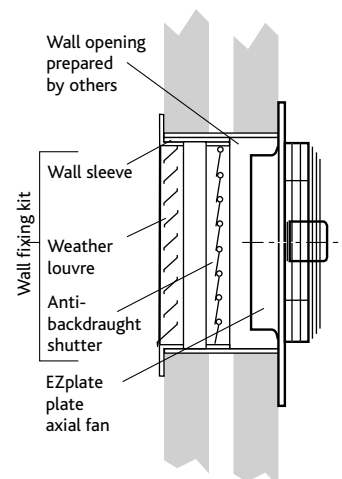

PERFORMANCE - EZPLATE AXIAL FANS

EZplate Axial Fan 4 Pole

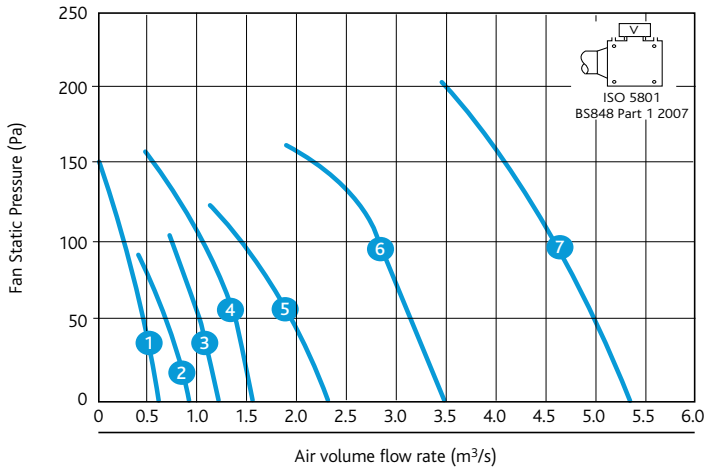

EZplate Axial Fan 6 Pole

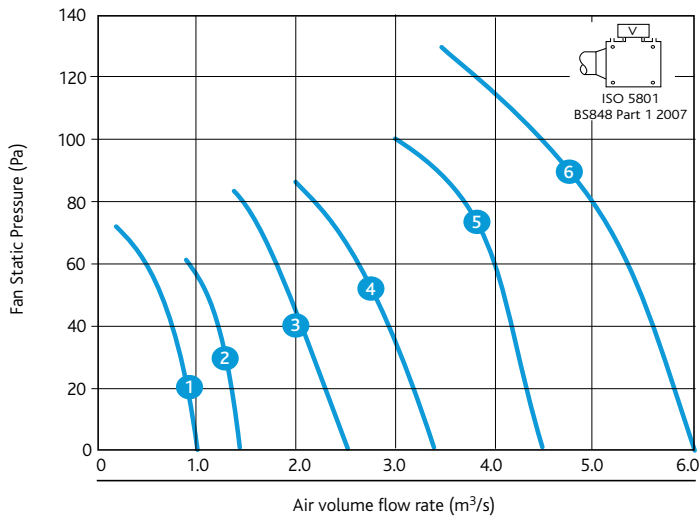

EZplate Axial Fan 8 Pole

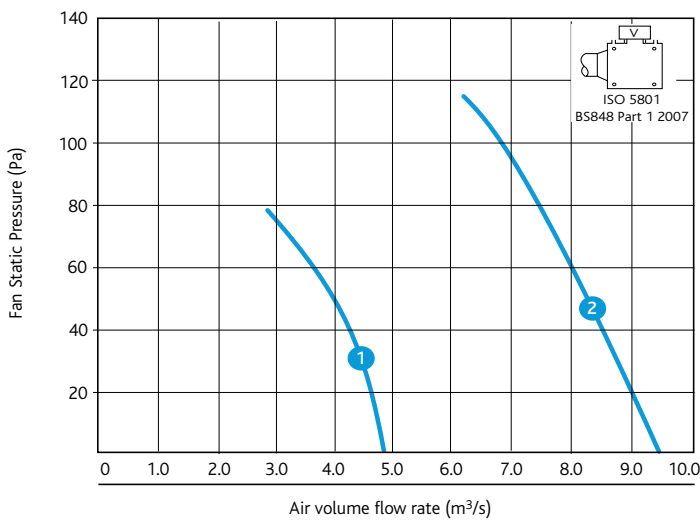

Casing

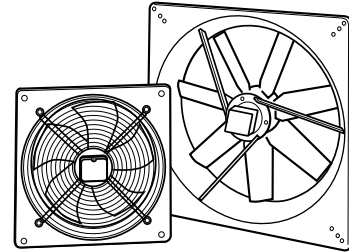

Code descriptions

EZPLATE 315 - 4 1



- 1. EZplate fan range
- 2. Fan size
- 3. 4 Pole (1440 rpm)
- 4. Electrical phase



EZPLATE AXIAL FANS

**ELECTRICAL & SOUND**

Curve	Fan Code	Phase	RPM	Motor Power (kW)	FLC (amps)	SC (amps)	Open	Sound Power Levels (dB re 1pW 10 -12 W)							dBA @ 3m
								Octave band mid frequency (Hz)							
								125	250	500	1K	2K	4K	8K	
<b>4 Pole</b>															
1	EZPLATE315-41	1	1420	0.19	0.76	3.0	Inlet	67	61	60	59	60	55	47	45
2	EZPLATE350-41	1	1400	0.21	0.93	3.7	Inlet	71	67	66	65	64	60	53	50
3	EZPLATE400-41	1	1430	0.24	1.01	4.0	Inlet	70	72	67	67	69	65	56	53
4	EZPLATE450-41	1	1390	0.24	1.1	4.4	Inlet	78	74	74	70	69	65	57	56
5	EZPLATE500-41	1	1290	0.78	3.4	7.1	Inlet	77	76	74	74	75	73	65	60
6	EZPLATE560-41	1	1330	1.5	6.5	14	Inlet	81	76	75	75	75	72	66	60
6	EZPLATE560-43	3	1280	1	1.9	6.2	Inlet	81	76	75	75	75	72	66	60
7	EZPLATE630-43	3	1360	1.9	3.2	14	Inlet	95	89	86	85	84	82	74	70
<b>6 Pole</b>															
1	EZPLATE450-61	1	940	0.16	0.79	3.16	Inlet	69	65	65	61	60	56	48	47
2	EZPLATE500-61	1	910	0.25	1.35	2.1	Inlet	70	72	67	67	69	65	56	53
3	EZPLATE560-61	1	910	0.4	2.0	4.6	Inlet	70	72	67	68	68	65	57	53
3	EZPLATE560-63	3	880	0.4	0.86	1.75	Inlet	70	72	67	68	68	65	57	53
4	EZPLATE630-61	1	880	0.6	2.7	5.3	Inlet	74	78	74	71	73	71	61	58
4	EZPLATE630-63	3	880	0.7	1.5	3.6	Inlet	74	78	74	71	73	71	61	58
5	EZPLATE710-61	1	850	0.8	4.1	8.0	Inlet	76	83	77	77	77	72	64	62
5	EZPLATE710-63	3	860	1.1	2.2	6.4	Inlet	76	83	77	77	77	72	64	62
6	EZPLATE800-63	3	920	1.7	3.3	12.0	Inlet	82	80	78	78	77	72	63	63
<b>8 Pole</b>															
1	EZPLATE800-83	3	680	0.85	1.95	7.8	Inlet	75	73	71	71	70	65	56	55
2	EZPLATE1000-83	6	50	2.3	4.2	16.8	Inlet	90	88	86	82	79	73	64	67

Note: Open inlet dBA@3m spherical free field.  
Electric and sound information in the table is nominal.

## AXIAL FANS

### EZPLATE

#### TECHNICAL INFORMATION

#### DIMENSIONS - EZPLATE AXIAL FANS

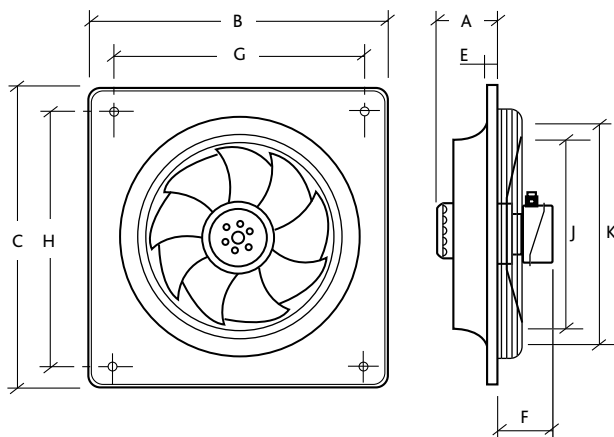

#### DIMENSIONS (mm)

Fan Unit	A	B	C	E	F	G	H	J	K	Weight Kg
EZPLATE315	73	430	430	11	60	380	380	324	330	5.0
EZPLATE350	80	485	485	12	60	435	435	368	375	7.0
EZPLATE400	98	540	540	12	60	490	490	412	420	8.0
EZPLATE450	100	575	575	14	60	535	535	463	480	11.0
EZPLATE500	120	655	655	16	61	615	615	517	535	18.0
EZPLATE560	136	725	725	16	46	675	675	568	590	21.0
EZPLATE630	130	805	805	16	44	750	750	643	670	31.0
EZPLATE710	170	850	850	20	20	810	810	721	765	35.0
EZPLATE800	210	970	970	20	17	910	910	807	870	50.0
EZPLATE1000	210	1170	1170	20	10	1110	1110	1010	1070	90.0

Please note: Inlet guards are not included for the 800mm and 1000mm fan units.

#### QUICK SELECTION GUIDE

#### EZPLATE

Fan Code	Outlet Shutter	Wall Kit	Inlet Finger Guard	Speed Control Electronic	Inverter	Transformer
EZPLATE315-41	P315BS	P315WK	-	ESC1-3A	-	SPCON3.5
EZPLATE350-41	P350BS	P350WK	-	ESC1-3A	-	SPCON3.5
EZPLATE400-41	P400BS	P400WK	-	ESC1-3A	-	SPCON3.5
EZPLATE450-41	P450BS	P450WK	-	ESC1-3A	-	SPCON3.5
EZPLATE500-41	P500BS	P500WK	-	ESC1-3A	-	SPCON3.5
EZPLATE560-41	P560BS	P560WK	-	ESC1-10A	-	SPCON7.5
EZPLATE560-43	P560BS	P560WK	-	-	3ISC3.0A	-
EZPLATE630-43	P630BS	P630WK	-	-	3ISC4.0A	-
EZPLATE450-61	P450BS	P450WK	-	ESC1-3A	-	SPCON3.5
EZPLATE500-61	P500BS	P500WK	-	ESC1-3A	-	SPCON3.5
EZPLATE560-61	P560BS	P560WK	-	ESC1-3A	-	SPCON3.5
EZPLATE630-61	P630BS	-	-	ESC1-6A	-	SPCON7.5
EZPLATE710-61	P710BS	-	-	ESC1-6A	-	SPCON7.5
EZPLATE560-63	P560BS	-	-	-	3ISC1.2A	-
EZPLATE630-63	P630BS	-	-	-	3ISC2.1A	-
EZPLATE710-63	P710BS	-	-	-	3ISC3.0A	-
EZPLATE800-63	P800BS	-	-	EZG800	-	3ISC4.0A
EZPLATE800-83	P800BS	-	-	EZG800	3ISC4.0A	-
EZPLATE1000-83	P1000BS	-	-	EZG1000	3ISC4.0A	-

#### CONTROLS - EZPLATE

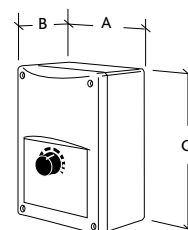

#### ELECTRONIC SPEED CONTROL (mm)

##### Dimensions (mm)

Unit Code	A	B	C	Weight Kg
NSC1-3A	83	88	180	0.5
NSC1-6A	115	95	195	0.7
NSC1-10A	115	95	195	0.7

The electronic speed controllers provide infinitely variable speed control from preset minimum to maximum. All models feature a boost start function, which applies maximum power to the motor for a few seconds to prevent motor stalling before returning to selected speed. Wiring to the motor can be either 2-wires or 3-wires control depending on the motor design. The enclosures for ESC1-3A and ESC1-6A are rated to IP45 with the ESC1-10A rated at IP54. All controllers meet LVD and EMC directives for safety and electromagnetic compatibility.

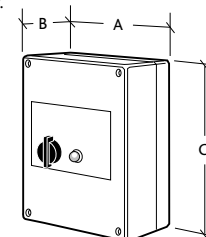

#### TRANSFORMER SPEED CONTROL (mm)

##### Single Phase Dimensions (mm)

Unit Code	A	B	C	Weight Kg
SPCON1.5	115	85	180	1.7
SPCON3.5	200	140	280	3.6
SPCON7.5	200	140	280	6.0

Autotransformers having class 'F' insulation are used to provide discrete voltage steps. All models are fitted with suitable fuses for short-circuit protection. The controller casing is manufactured from plastic pre-coated steel or impact resistant polycarbonate. All models are suitable for indoor installations only. All controllers meet LVD and EMC directives for safety and electromagnetic compatibility. Transformer speed controls produce a pure sine wave output resulting in quiet motor operation. Transformer controls are therefore preferred for noise sensitive applications.

ANCILLARIES - EZPLATE

**GRAVITY BACKDRAUGHT SHUTTER (mm)**

Shall be manufactured in UV stabilised, impact resistant polypropylene. Resistance to airflow for this item is negligible.

Typical code: P315BS

Dimensions in (mm)

Code	A	B	C	D	Weight Kg
P315BS	26	276	347	9	0.5
P350BS	26	310	397	9	0.5
P400BS	26	364	459	9	0.5
P450BS	26	395	501	11	1.0
P500BS	31	445	549	11	1.0
P560BS	31	522	604	11	1.0
P630BS	31	628	697	11	1.0

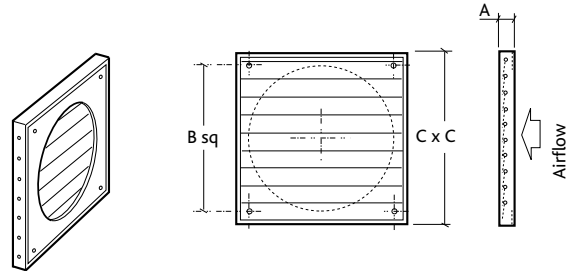

**WALL FIXING KIT (mm)**

Shall comprise an external weather louvre with bird screen, gravity back draught shutter and a wall sleeve.

Typical code: P315WK

Dimensions in (mm)

Code	A	B	C	D	E	Weight Kg
P315WK	390	375	360	200	9	2.0
P350WK	440	425	410	200	9	3.0
P400WK	500	485	470	200	9	3.0
P450WK	545	530	515	200	11	4.0
P500WK	590	575	560	225	11	5.0
P560WK	650	635	620	225	11	5.0
P630WK	730	715	700	225	11	7.0

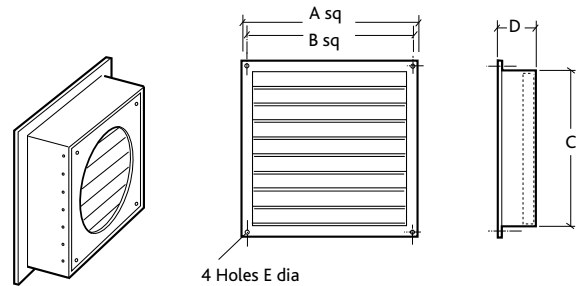

**FINGER GUARD (mm)**

Manufactured from galvanised steel. Resistance to airflow for this item is negligible.

Typical code: EZG800

Dimensions in (mm)

Code	A	B
EZG800	929	960
EZG1000	1109	1140

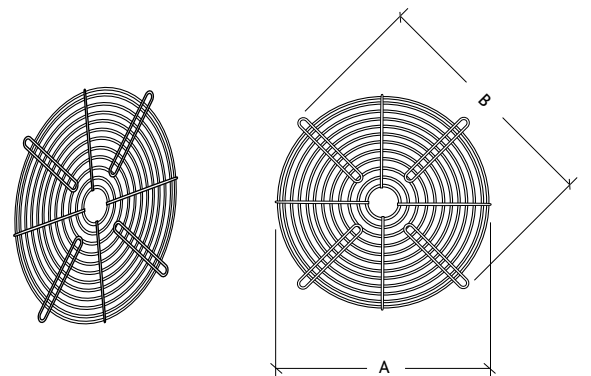

WIRING - EZPLATE

Single Phase Fans

Single Speed units

Note: Failure to connect Thermal Protection TB or TK as shown will invalidate warranty

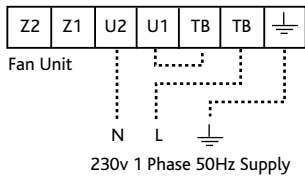

Three Phase Fans

Single Speed units

(Interchange any two Fan supply phases to reverse rotation)

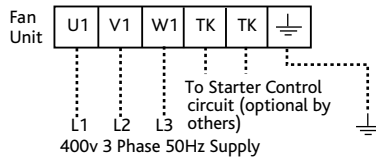

Note: If starter control fitted, failure to connect Thermal Protection TW or TK as shown will invalidate warranty

Units with ELECTRONIC Speed Control

Note: Failure to connect Thermal Protection TB or TK as shown will invalidate warranty

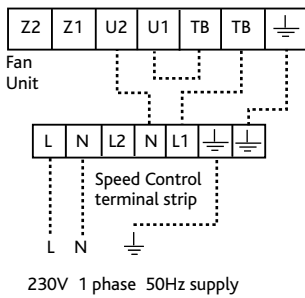

Unit with Speed Control INVERTER TYPE 3SC INV

NOTE: Refer to instructions supplied with Inverter for specific wiring details. Inverter instructions must be strictly observed

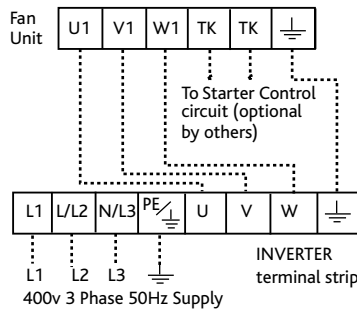

Note: If starter control fitted, failure to connect Thermal Protection TW or TK as shown will invalidate warranty

Units with AUTO-TRANSFORMER

Speed Control

Note: Failure to connect Thermal Protection TB or TK as shown will invalidate warranty

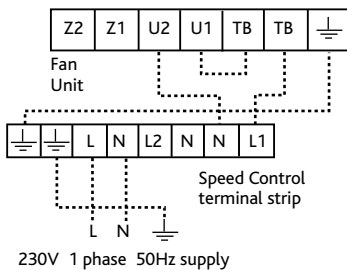

## CONSULTANTS SPECIFICATION

### FAN SPECIFICATION

The extract fans shall be as indicated on the drawings and shall be in accordance with the particular fan schedule in this specification. The vitiated air shall be extracted from each area as shown. All necessary fittings and ancillaries shall be allowed for by the mechanical sub contractor.

The unit shall be provided with a wall mounting kit comprising an external weather louvre, backdraught shutter and mounting/wall sleeve.

The ventilation fan shall be of the EZPLATE type axial flow fan as manufactured by Nuair Ltd. The fan mounting plate shall be manufactured in a one-piece pressed steel construction for rigidity and is polyester powder coated. The case shall be fitted with an external terminal box to IP54.

The fan impeller and motor shall be selected to provide the most energy efficient solution conforming to part L regulations and shall be direct drive with IE2 high efficiency external rotor motors for long life and trouble-free operation to BS5000 as standard with IP54 (IP44 315 to 450mm) enclosures and class F insulation in accordance with BS4999 part 20. They shall have sealed for life ball bearings. Motors shall be pre-wired to an external electrical terminal box through flexible conduit to IP54 and shall be fitted with Heatseeker' thermal overload protection.

The units shall be suitable for operation in ambient temperatures up to 55°C. The impeller blades shall be of special sickle blade or aero-foil section giving excellent performance and low noise characteristic.

Fan sizes 315 to 450 use advanced design pressed steel blades of sickle blade design. All other sizes use die-cast aluminium blades with high efficiency aerofoil sections. Fans up to 710mm diameter inclusive are fitted with inlet finger guard to BS848 part 5. Finger guards for other sizes are available as an optional ancillary. All units can be installed at any angle.

The unit shall be of the EZPLATE type as manufactured by Nuair Ltd.

### CONTROL OPTION

The unit shall be provided with a standard speed control or starter in accordance with the manufacturers recommendations.

The unit and ancillaries shall be supplied with a 3 years manufacturers warranty.

All equipment shall be as manufactured by Nuair Ltd.