

XS EXTRACT FANS

WIDE RANGE OF MULTIPURPOSE WALL, WINDOW AND ROOF EXTRACT FANS WITH OPTIONAL INTEGRATED CONTROLS.



BENEFITS

MARKET LEADING DESIGN

Wide range to suit most applications including wall, window, roof and ceiling (6, 9 & 12").

QUIETEST OPERATION

Ultra quiet wax thermo actuator, together with market leading motor and impeller technology combine to produce one of the quietest wall fans available.

'MULTI' FAN SPEED CONTROL

Allows up to 5 fans to be connected to one speed control.

HIGH PERFORMANCE

High efficiency impeller and external rotor motor out performs (up to 530l/s/ 1908m³/hr) its competitors at much lower noise levels (from 31dBA).

FLEXIBLE SOLUTION

Reversible for extract and input with infinitely variable speed control.

SAVE ENERGY & MONEY

Economy speed setting that will maximise performance at the lowest energy use.

COMPLETE USER SAFETY

Robust construction, manufactured from flame retardant ABS polymer IP44 rated for long life.

EASY REFURBISHMENT

XS refurb kits are quick to install and can be used to replace most existing systems.

FLEXIBLE CONTROLS

A wide range of sensors including PIR, humidity, air quality, run on timer and thermostat can be integral within the unit or mounted separately.

EASY TO SPECIFY AND ORDER

Fans are supplied complete with kit ensuring no missing components on-site.

WARRANTY

XS has a 3 year warranty.

TYPICAL INSTALLATION

Exposed site window installation (use with Window Fan Kit)

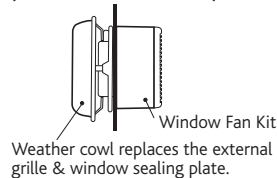

Exposed site wall installation (use with Wall Fan Kit)

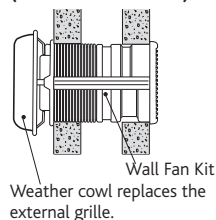

Flat roof (ducted to ceiling) installation (use with Ceiling Fan Kit)

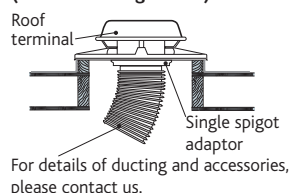

Pitched roof (ducted to ceiling) installation (use with Pitched Roof Fan Kit)

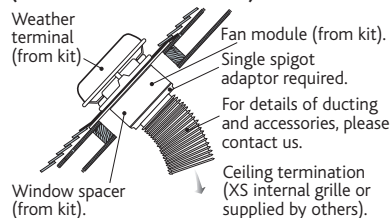

In-Duct installation (use with Basic Fan Unit)

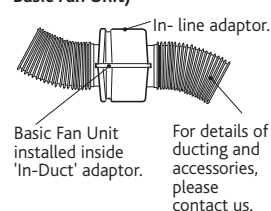

Ceiling mounted fans for ducted applications

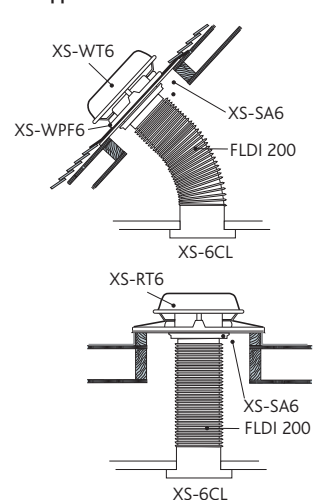

PERFORMANCE - XS (GL) WINDOW EXTRACT FANS

XS 6, 9 and 12GL Window Fans. Performance represents complete fan kit

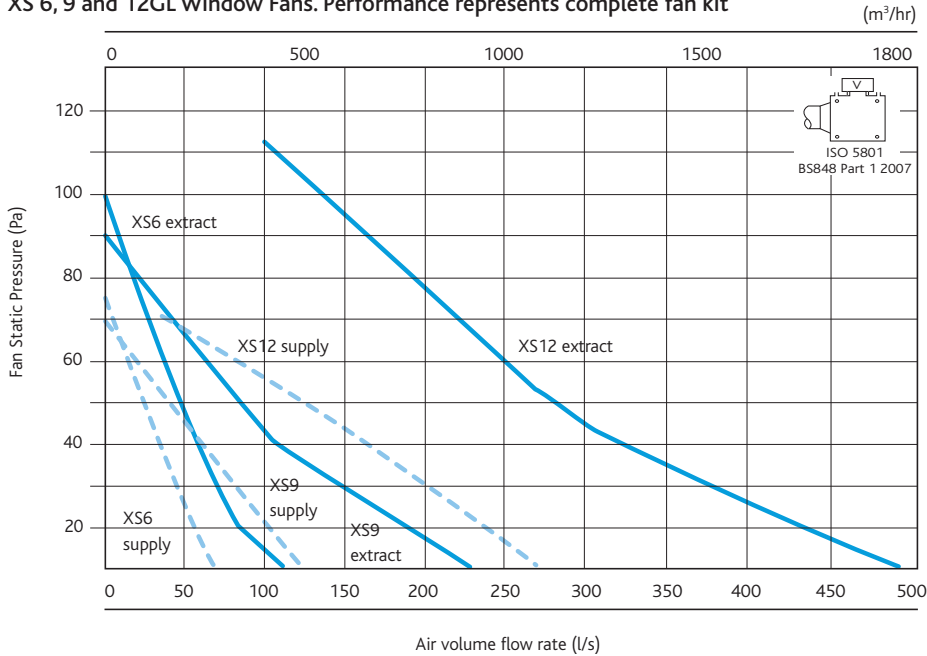

Casing

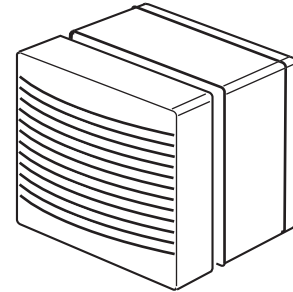

Code descriptions

XS 6 GL



- 1. XS range
- 2. Size indication
- 3. GL = Window model

ELECTRICAL & SOUND

Code	Noise/Sound levels (dBA @ 3m)				Input power (watts)	
	Extract	Extract economy	Supply	Supply economy	Standard	Economy
XS6GL	42	31	43	32	38	20
XS9GL	41	30	43	32	50	37
XS12GL	47	36	48	37	100	70

FAN PRESSURE PA

XS6GL Extract	0	20	40	60
Air Volume Flow rate (l/s)	130	105	65	40
Input Power (w)	36	37	37	37
SFP(W/l/s)	0.3	0.4	0.6	0.9
XS9GL Extract				
Air Volume Flow rate (l/s)	230	180	105	50
Input Power (w)	50	50	50	51
SFP(W/l/s)	0.2	0.3	0.5	1.0
XS12GL Extract				
Air Volume Flow rate (l/s)	530	440	340	260
Input Power (w)	103	106	106	108
SFP(W/l/s)	0.2	0.2	0.3	0.4

For SFP please contact Nuair.

XS (GL) WINDOW FAN KITS

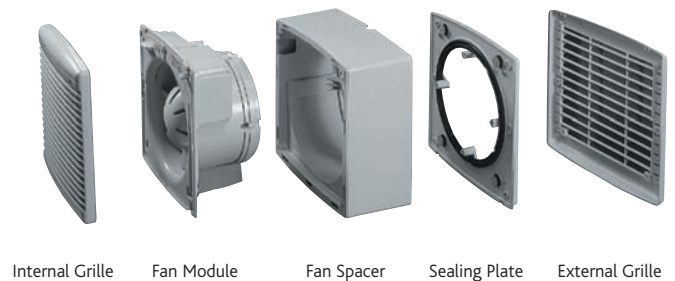

6" Fan XS6GL

9" Fan XS9GL

12" Fan XS12GL

Front view

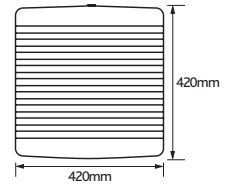
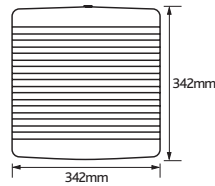
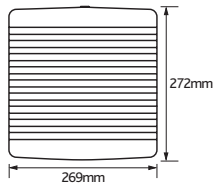

Rear view

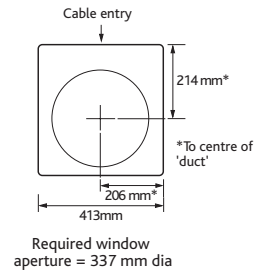
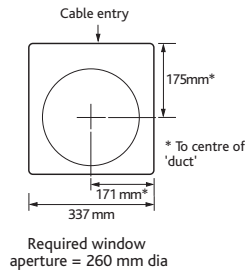
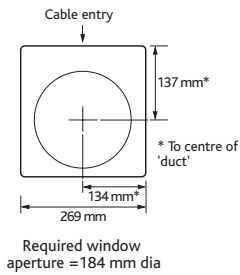

Side view

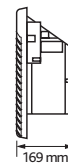
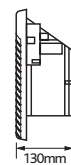
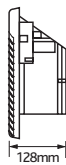

XS (GL) WINDOW FAN KIT INSTALLATION

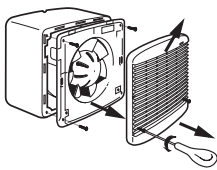

Remove front grille. Release screws, lift grille upward.

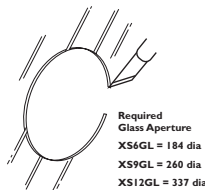

Prepare window.

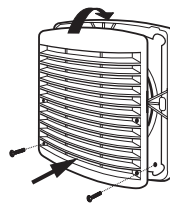

Fix outer grille to spigot plate. Check plate orientation is vertical. Note grille locates over top lugs on spigot plate.

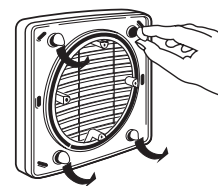

Remove adhesive pad covers.

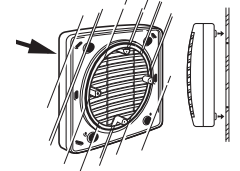

Clean the window glass and affix the outer grille assembly over the window aperture.

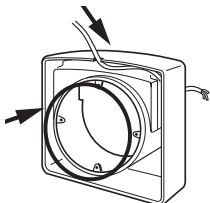

Ensure rubber seal is located into case spigot. Feed cable into the case.

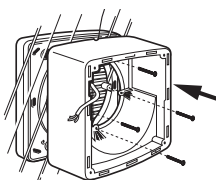

Screw the case/grille assembly together.

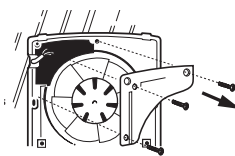

Release the electrical cover from the fan plate. Bring the cable through the fan plate.

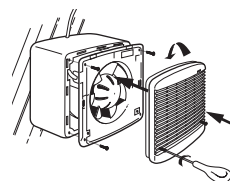

Assemble the fan plate to the case. Fit the inside grille locating it over the top lip before engaging screws

For further information please refer to full installation and wiring diagram.

PERFORMANCE - XS (PR/FR) ROOF EXTRACT FANS

XS 6, 9 and 12PR/FR Roof Fans. Performance represents complete fan kit

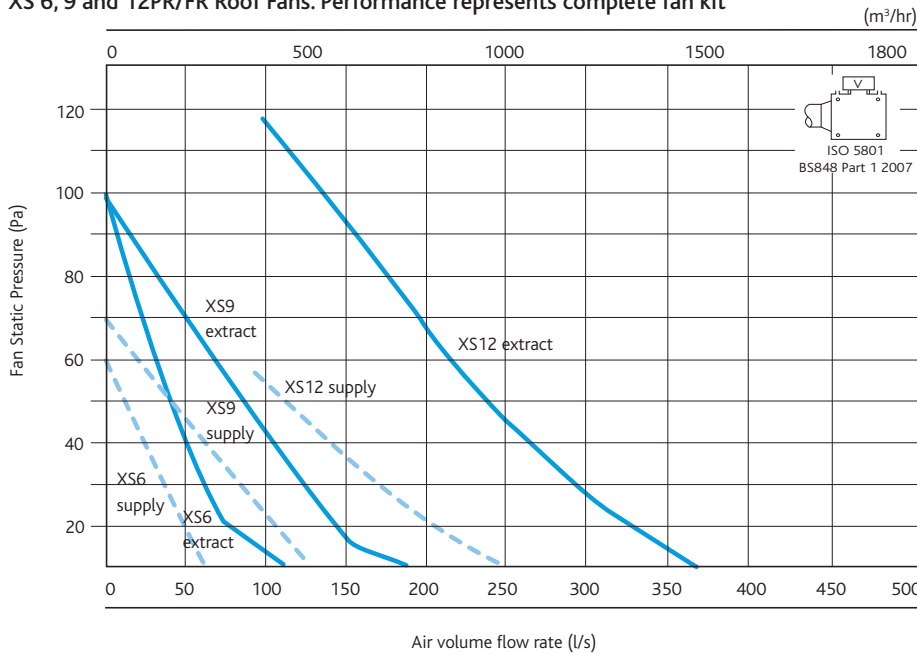

Casing

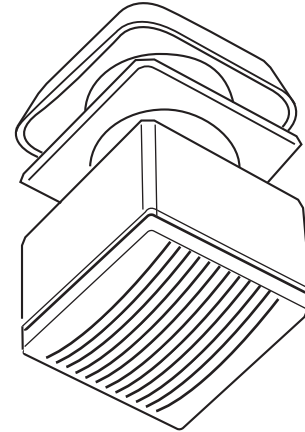

Code descriptions

XS 6 PR/FR



- 1. XS range
- 2. Size indication
- 3. PR/FR = Roof model

ELECTRICAL & SOUND

Code	Noise/Sound levels (dBA @ 3m)				Input power (watts)	
	Extract	Extract economy	Supply	Supply economy	Standard	Economy
XS6PR/FR	42	31	45	34	38	38
XS9PR/FR	41	30	43	32	50	37
XS12PR/FR	49	38	48	37	100	70

FAN PRESSURE PA

XS6PR/FR Extract	0	20	40	60
Air Volume Flow rate (l/s)	130	105	65	40
Input Power (w)	36	37	37	37
SFP(W/l/s)	0.3	0.4	0.6	0.9
XS9PR/FR Extract				
Air Volume Flow rate (l/s)	230	180	105	50
Input Power (w)	50	50	50	51
SFP(W/l/s)	0.2	0.3	0.5	1.0
XS12PR/FR Extract				
Air Volume Flow rate (l/s)	530	440	340	260
Input Power (w)	103	106	106	108
SFP(W/l/s)	0.2	0.2	0.3	0.4

XS (PR/FR) ROOF FAN KITS

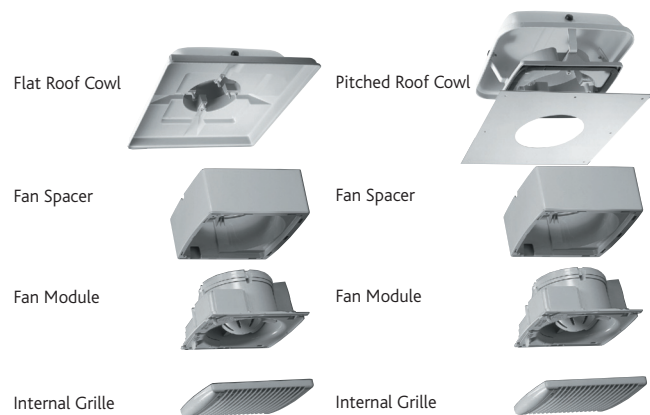

DIMENSIONS (MM)

XS	6	9	12
A x A	272x272	342x342	420x420
B	161	158	172
C	150	150	150
D	170	180	185
Kg	6.3	9.1	11.8

A = Opening size

B = Overall size

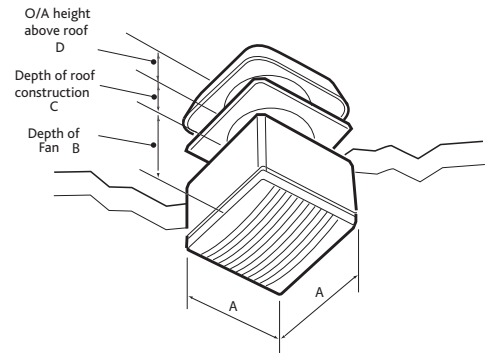

XS (PR/FR) ROOF FAN KIT INSTALLATION

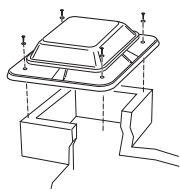

Drill through the dimples in the roof terminal. Position centrally & squarely over curb and fix using 6mm wood screws and sealing washers.

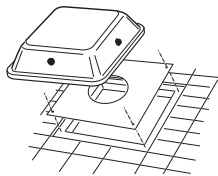

Fix the wall fixing plate centrally over the roof aperture. Locate the weather terminal centrally over the plate. Use the foam adhesive strip to fix.

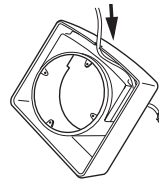

Feed the supply cable through the spacer.

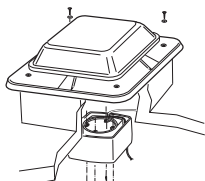

Offer up the spacer section to the terminal underside using 4.5mm screws provided.

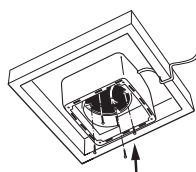

Offer the spacer section up and fix through to the weather terminal fixing inserts.

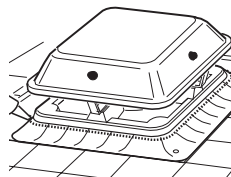

Apply flashing from the tiles, over the fixing plate and overlap the base roof terminal by 25mm.

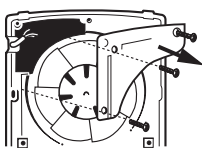

Release the electrical cover from the fan plate. For various wiring options.

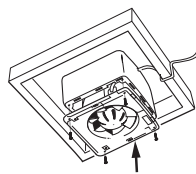

Assemble the fan to the spacer section 4 set screws.

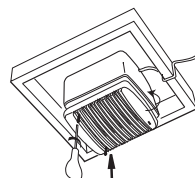

Fit the grille to the fan, locating top lip before fixing.

For further information please refer to full installation and wiring diagram.

PERFORMANCE - XS (WA) WALL EXTRACT FANS

XS 6, 9 and 12WA Wall Fans. Performance represents complete fan kit

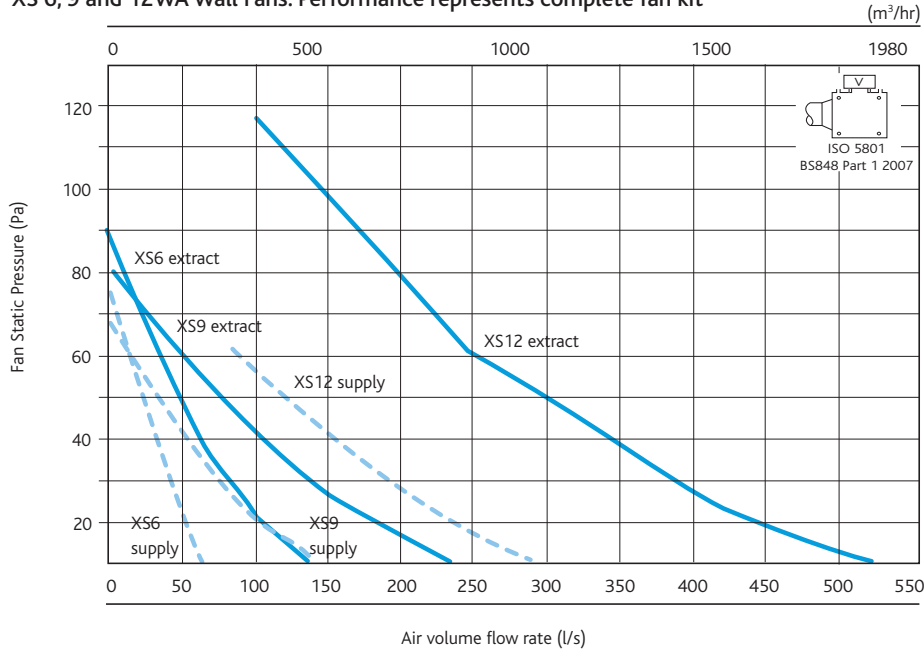

Casing

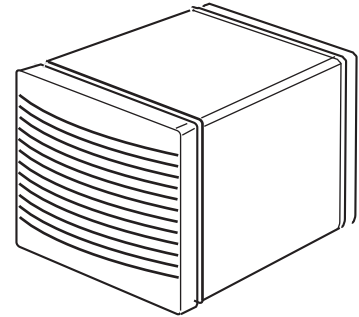

Code descriptions

XS 9 WA



- 1. XS range
- 2. Size indication
- 3. WA = Wall model

ELECTRICAL & SOUND

Code	Noise/Sound levels (dBA @ 3m)				Input power (watts)	
	Extract	Extract economy	Supply	Supply economy	Standard	Economy
XS6WA	42	31	45	34	38	20
XS9WA	45	34	45	34	50	37
XS12WA	47	36	47	36	100	70

FAN PRESSURE PA

Code	0	20	40	60
XS6WA Extract				
Air Volume Flow rate (l/s)	130	105	65	40
Input Power (w)	36	37	37	37
SFP(W/l/s)	0.3	0.4	0.6	0.9
XS9WA Extract				
Air Volume Flow rate (l/s)	230	180	105	50
Input Power (w)	50	50	50	51
SFP(W/l/s)	0.2	0.3	0.5	1.0
XS12WA Extract				
Air Volume Flow rate (l/s)	530	440	340	260
Input Power (w)	103	106	106	108
SFP(W/l/s)	0.2	0.2	0.3	0.4

XS (WA) WALL FAN KITS

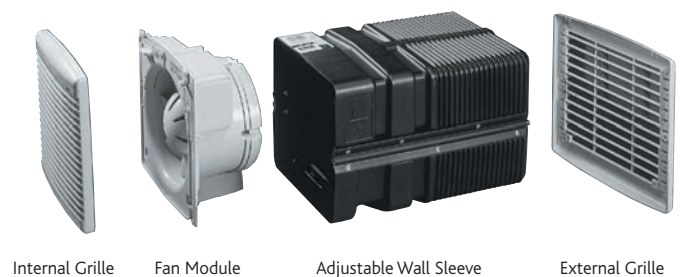

6" Fan XS6WA

9" Fan XS9WA

12" Fan XS12WA

Front view

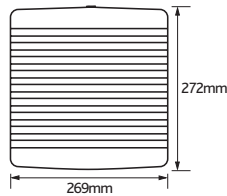

Aperture required
260 mm x 260 mm sq.

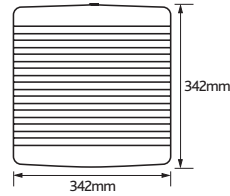

Aperture required
330 mm x 330 mm sq.

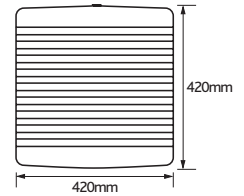

Aperture required
410 mm x 410 mm sq.

Rear view

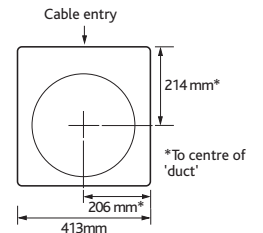
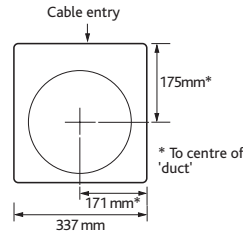
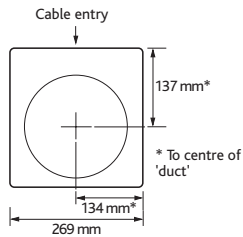

Side view

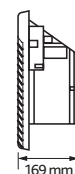
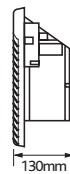
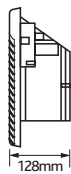

XS (WA) WALL FAN KIT INSTALLATION

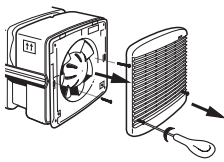

Remove front grille, release screws, lift grille. Remove fan.

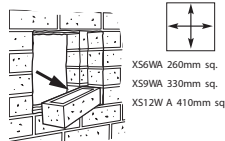

Prepare the wall aperture to dimensions shown.

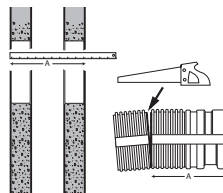

Cut the spacer to match the walls total thickness using a fine/med cut wood saw.

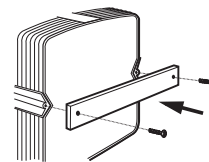

Fit temporary cross brace across wall sleeves outer end to support the side during installation.

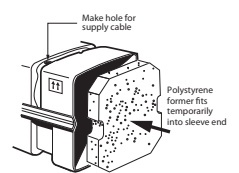

Locate the temporary plug to support the end.

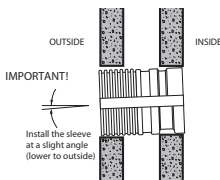

When fitting the sleeve, introduce a slight downward slope to the outside, this will allow any water to drain out.

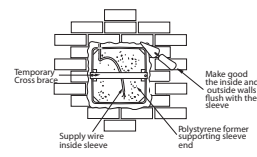

Make good the wall sleeve. Remove the temporary cross brace when the cement is dry and fit the outer grille (note grille blocks sloping downwards to shed water).

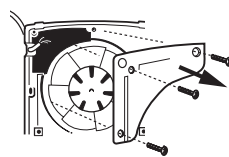

Release the electrical case from the plate. Bring the cable through the fan plate.

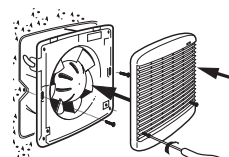

Assemble the fan to the inner sleeve. Fit the inside grille to the fan plate locating grille over the top lip before engaging screws.

PERFORMANCE - XS (CL) CEILING EXTRACT FANS

XS 6, 9 and 12CL Ceiling Fans. Performance represents complete fan kit

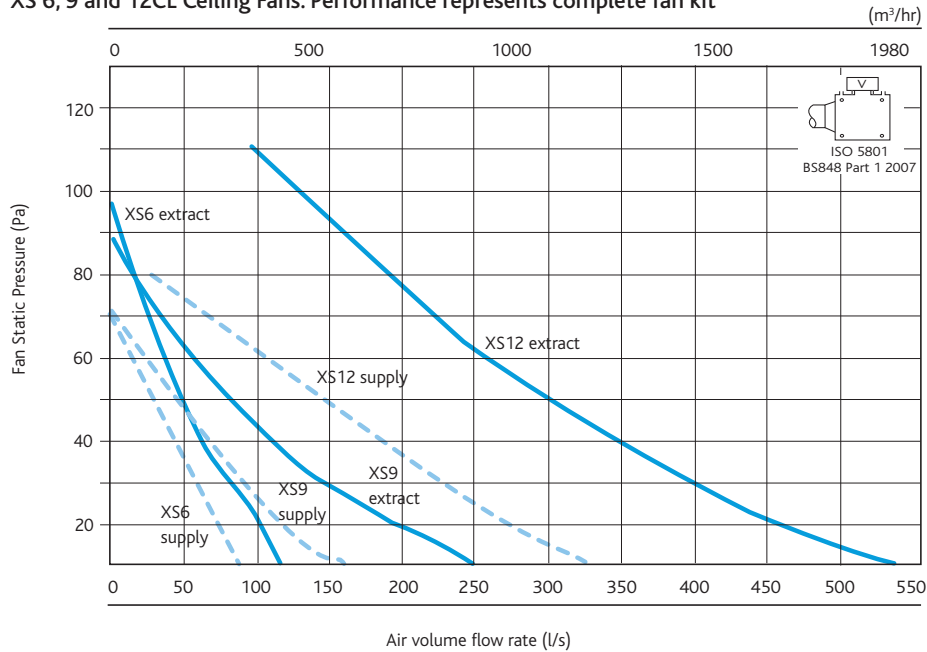

Casing

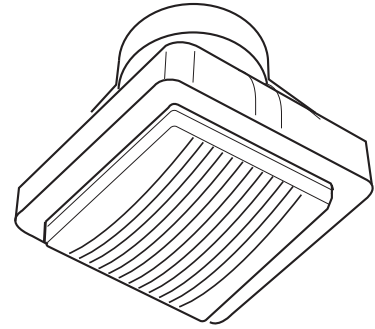

Code descriptions

XS 6 CL



1. XS range
2. Size indication
3. CL = Ceiling model

ELECTRICAL & SOUND

Code	Noise/Sound levels (dBA @ 3m)				Input power (watts)	
	Extract	Extract economy	Supply	Supply economy	Standard	Economy
XS6CL	42	31	45	35	38	20
XS9CL	41	30	43	32	50	37
XS12CL	49	38	48	37	100	70

FAN PRESSURE PA

XS6CL Extract	0	20	40	60
Air Volume Flow rate (l/s)	130	105	65	40
Input Power (w)	36	37	37	37
SFP(W/l/s)	0.3	0.4	0.6	0.9

XS9CL Extract	230	180	105	50
Air Volume Flow rate (l/s)	230	180	105	50
Input Power (w)	50	50	50	51
SFP(W/l/s)	0.2	0.3	0.5	1.0

XS12CL Extract	530	440	340	260
Air Volume Flow rate (l/s)	530	440	340	260
Input Power (w)	103	106	106	108
SFP(W/l/s)	0.2	0.2	0.3	0.4

XS (CL) CEILING FAN KITS

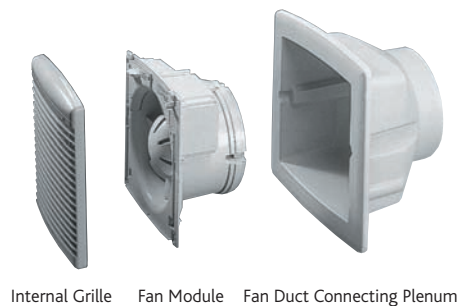

Internal Grille Fan Module Fan Duct Connecting Plenum

6" Fan XS6CL

9" Fan XS9CL

12" Fan XS12CL

Front view

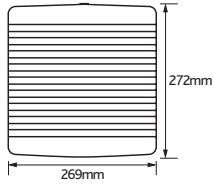

Required ceiling / panel aperture
270mm x 270mm square

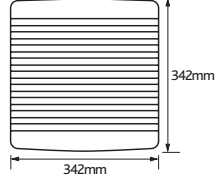

Required ceiling / panel aperture
340mm x 340mm square

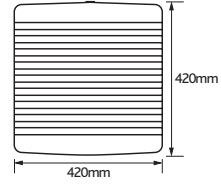

Required ceiling / panel aperture
430mm x 430mm square

Rear view

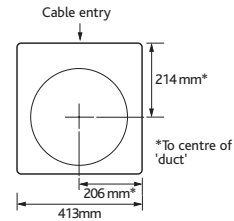
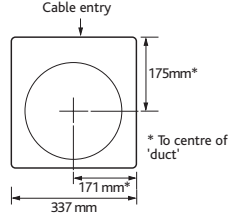
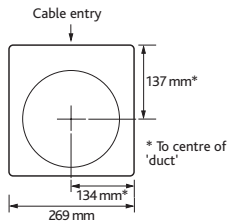

Side view

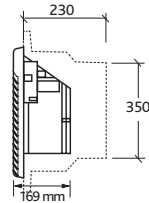
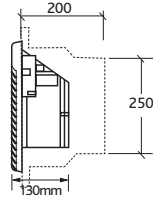
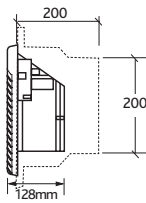

XS (CL) CEILING FAN KIT INSTALLATION

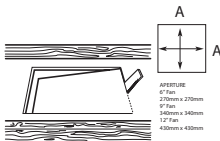

Prepare aperture to suit the fan size.

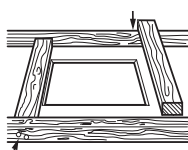

Cut and fit timber supports (not supplied) for aperture as shown.

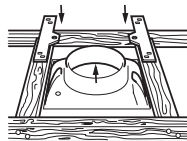

Offer the duct adaptor and two metal brackets into position.

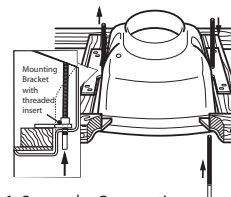

1: Screw the 2 mounting rods into the brackets from below.
2: Lock the screw rods with the nuts provided.

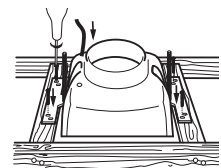

Fit metal brackets to the cross battens. Feed the the supply cable through the duct adaptor.

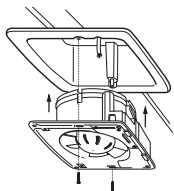

Offer the fan up into the duct adaptor and fix using the two screws.

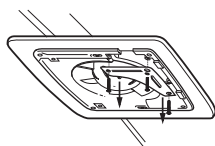

Remove the electrical connection panel (top left).

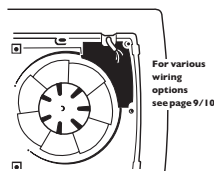

Bring the cable through the fan late approx 150mm.

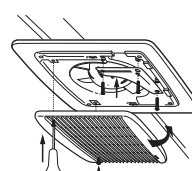



Fix the electrical connection before offering up the internal grille. Note grille clips over the top edge before fixing.

XS FAN ANCILLARIES

Unit Size	Speed Control	Integral Sensors					Remote Sensors			Refurb Kit
		PIR	Humidistat	Air Quality	Timer	Temp	PIR	Humidistat	Air Quality	
Desc	With Economy 50% setting, forward, reverse on/off switch.									Fan, frame adaptor, 2 fixing brackets Suits all leading brands.
Wall										
6	XS-MFC	XS-PIR6	XS-H6	XS-AQ6	XS-TA6	XS-TH6	XS-PIRR	XS-HR	XS-AQR	XS6RE
9	XS-MFC	XS-PIR9	XS-H9	XS-AQ9	XS-TA9	XS-TH9	XS-PIRR	XS-HR	XS-AQR	XS9RE
12	XS-MFC	XS-PIR12	XS-H12	XS-AQ12	XS-TA12	XS-TH12	XS-PIRR	XS-HR	XS-AQR	XS12RE
Window										
6	XS-MFC	XS-PIR6	XS-H6	XS-AQ6	XS-TA6	XS-TH6	XS-PIRR	XS-HR	XS-AQR	XS6RE
9	XS-MFC	XS-PIR9	XS-H9	XS-AQ9	XS-TA9	XS-TH9	XS-PIRR	XS-HR	XS-AQR	XS9RE
12	XS-MFC	XS-PIR12	XS-H12	XS-AQ12	XS-TA12	XS-TH12	XS-PIRR	XS-HR	XS-AQR	XS12RE
Ceiling										
6	XS-MFC	XS-PIR6	XS-H6	XS-AQ6	XS-TA6	XS-TH6	XS-PIRR	XS-HR	XS-AQR	XS6RE
9	XS-MFC	XS-PIR9	XS-H9	XS-AQ9	XS-TA9	XS-TH9	XS-PIRR	XS-HR	XS-AQR	XS9RE
12	XS-MFC	XS-PIR12	XS-H12	XS-AQ12	XS-TA12	XS-TH12	XS-PIRR	XS-HR	XS-AQR	XS12RE
Flat Roof										
6	XS-MFC	XS-PIR6	XS-H6	XS-AQ6	XS-TA6	XS-TH6	XS-PIRR	XS-HR	XS-AQR	XS6RE
9	XS-MFC	XS-PIR9	XS-H9	XS-AQ9	XS-TA9	XS-TH9	XS-PIRR	XS-HR	XS-AQR	XS9RE
12	XS-MFC	XS-PIR12	XS-H12	XS-AQ12	XS-TA12	XS-TH12	XS-PIRR	XS-HR	XS-AQR	XS12RE
Pitch Roof										
6	XS-MFC	XS-PIR6	XS-H6	XS-AQ6	XS-TA6	XS-TH6	XS-PIRR	XS-HR	XS-AQR	XS6RE
9	XS-MFC	XS-PIR9	XS-H9	XS-AQ9	XS-TA9	XS-TH9	XS-PIRR	XS-HR	XS-AQR	XS9RE
12	XS-MFC	XS-PIR12	XS-H12	XS-AQ12	XS-TA12	XS-TH12	XS-PIRR	XS-HR	XS-AQR	XS12RE

Note: * On fan sizes 6/9 up to 5 fans can be controlled. On fan size 12 up to 3 can be controlled.

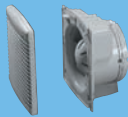
** Do not mix different fan sizes on the same controller.

								
Basic Fan Unit	Window Spacer	Single Spigot Adaptor	Weather Terminal	Roof Terminal	In-line Adaptor	Wall Fixing Plate	Picture Frame Adaptor	Extended Fixing Rods
Fan, module internal grille.	Used for exposed site installation 1 spacer. Use with weather terminals.	For ducted systems. To be mounted onto front of XS-WS.	For exposed window installations. Used with XS-WS.	No fan included.	For use with in-line duct applications.	Used for timber and thin walls, pitched roof and above ceiling. One fixing plate. Used with window kits spacers &/or weather terminals.	For panel, ceiling or retro installations where uneven walls need to be fixed.	For glazing over 32mm and up to 360mm thick.
Wall cont.								
XS6	XS-WS6	XS-SA6	XS-WT6	N/A	XS-IDK6	N/A	XS-PFA6	N/A
XS9	XS-WS9	XS-SA9	XS-WT9	N/A	XS-IDK9	N/A	XS-PFA9	N/A
XS12	XS-WS12	XS-SA12	XS-WT12	N/A	XS-IDK12	N/A	XS-PFA12	N/A
Window cont.								
XS6	XS-WS6	XS-SA6	XS-WT6	N/A	N/A	XS-WFP6	N/A	XS-EFR
XS9	XS-WS9	XS-SA9	XS-WT9	N/A	N/A	XS-WFP9	N/A	XS-EFR
XS12	XS-WS12	XS-SA12	XS-WT12	N/A	N/A	XS-WFP12	N/A	XS-EFR
Ceiling cont.								
XS6	N/A	XS-SA6	XS-WT6	XS-RT6	XS-IDK6	XS-WFP6	XS-PFA6	N/A
XS9	N/A	XS-SA9	XS-WT9	XS-RT9	XS-IDK9	XS-WFP9	XS-PFA9	N/A
XS12	N/A	XS-SA12	XS-WT12	XS-RT12	XS-IDK12	XS-WFP12	XS-PFA12	N/A
Flat Roof cont.								
XS6	N/A	XS-SA6	N/A	N/A	XS-IDK6	XS-WFP6	XS-PFA6	N/A
XS9	N/A	XS-SA9	N/A	N/A	XS-IDK9	XS-WFP9	XS-PFA9	N/A
XS12	N/A	XS-SA12	N/A	N/A	XS-IDK12	XS-WFP12	XS-PFA12	N/A
Pitch Roof cont.								
XS6	N/A	XS-SA6	N/A	XS-RT6	XS-IDK6	XS-WFP6	XS-PFA6	N/A
XS9	N/A	XS-SA9	N/A	XS-RT9	XS-IDK9	XS-WFP9	XS-PFA9	N/A
XS12	N/A	XS-SA12	N/A	XS-RT12	XS-IDK12	XS-WFP12	XS-PFA12	N/A

XS CONTROLS



MULTI-FAN CONTROL

Fitting Remote Controller XS-MFC or Remote Sensors (optional)

The XS-MFC Multi Fan Control provides supply or extract, variable speed and automatic or manual switching of several fans if desired.

The control is best mounted approx. 1.5m above the floor. Remote Sensors are available for Humidity, Air Quality and Passive Infra Red control.

Remote Sensors should be positioned at least 1.5m above the floor and away from direct heat sources e.g. radiators.

NOTE:
Up to 5 fans (size 6"/9") can be controlled by one XS-MFC.
Up to 3 fans (size 12") can be controlled by one XS-MFC.
Do not mix different fans sizes on the same controller.



Description	Length	Depth	Height
Remote Control	155	87	60

Speed Control;
with "Economy" (50%) setting, forward and reverse, on/off switches.
Typical code: XS-MFC

INTEGRAL SENSORS

Fan Size	PIR	Humidistat	Air Quality	Timer	Temp
6	XS-PIR6	XS-H6	XS-AQ6	XS-TA6	XS-TH6
9	S-PIR9	XS-H9	XS-AQ9	XS-TA9	XS-TH9
12	XS-PIR12	XS-H12	XS-AQ12	XS-TA12	XS-TH12

REMOTE SENSORS

Fan Size	PIR	Humidistat	Air Quality
6	XS-PIRR	XS-HR	XS-AQR
9	XS-PIRR	XS-HR	XS-AQR
12	XS-PIRR	XS-HR	XS-AQR

WIRING - XS

Refurbishment Installation

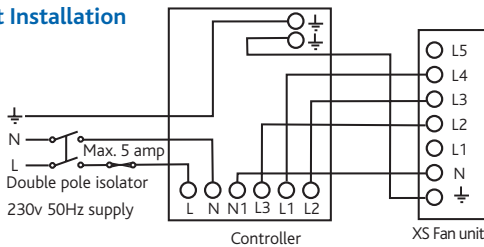

This arrangement will give the following operating features:

- Adjustable speed
- Adjustable minimum speed
- Extract/intake
- Fan off - shutter open
- Fan off - shutter closed

Limitations are:

- Control of single fan only
- Integral sensors not possible
- Automatic ECO setting not available

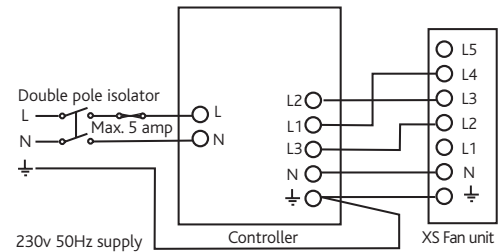

This arrangement will give the following operating features:

- Single speed
- Extract/intake
- On/off

Limitations are:

- Control of single fan only
 - Integral sensors not possible
 - Automatic ECO setting not available
- Fans should be installed in line with the IEE wiring regulations.

Fan Operated by On/Off Switch

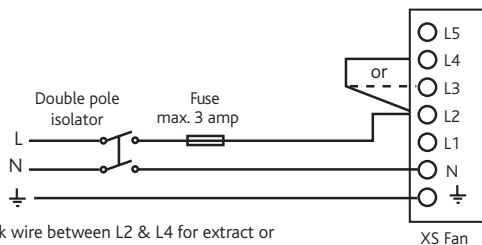

Connect link wire between L2 & L4 for extract or
Connect link wire between L2 & L3 for supply.

Basic Fan Operated by Remote Sensor

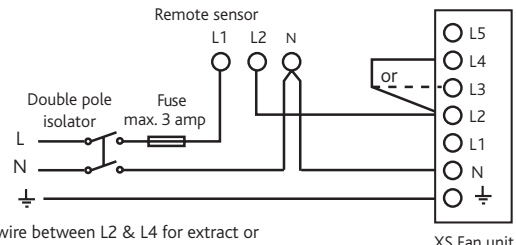

Connect link wire between L2 & L4 for extract or
Connect link wire between L2 & L3 for supply.

Fan Operated by Integral Sensor

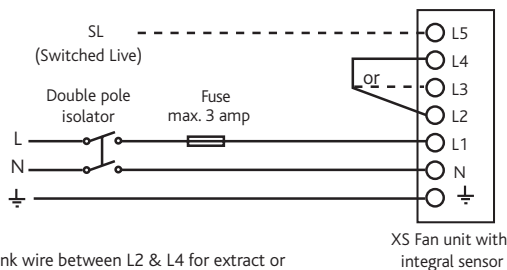

Connect link wire between L2 & L4 for extract or
Connect link wire between L2 & L3 for supply.
Connect switched live signal to L5 for integral timer module.

Supply / Extract Fan Operated via Remote XS-MFC Control

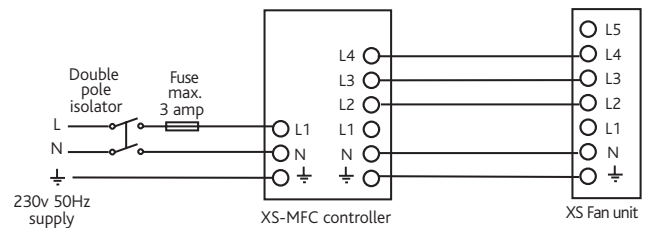

Remote switch may be set: On / Off, Forward / Reverse, Economy / Std. (variable speed), Auto / Manual.

Supply / Extract Fan operated via Remote XS-MFC Control & Remote Sensor(s)

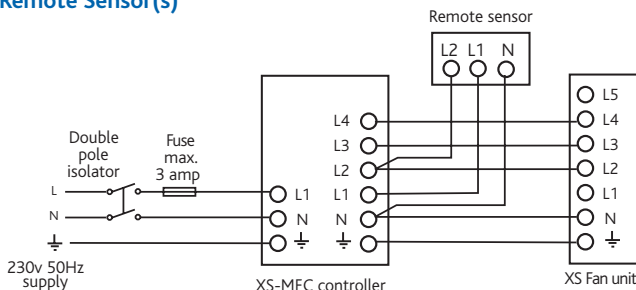

Remote switch may be set: On / Off, Forward / Reverse, Economy / Std.(variable speed), Auto / Manual.

One or more Remote Sensors may be wired in parallel to one XS-MFC Control.

Humidity Sensor: XS-HR, Air Quality Sensor: X S-AQR.

Passive Infra Red Sensor: XS-PIRR.

Note: Multi-fan options:

Up to 5 fans (size 6" / 9") can be controlled by one XS-MFC. Up to 3 fans (size 12") can be controlled by one XS-MFC. Do not mix different fan sizes on the same controller.

Supply / Extract Fan Operated via Remote XS-MFC Control and Integral Sensor

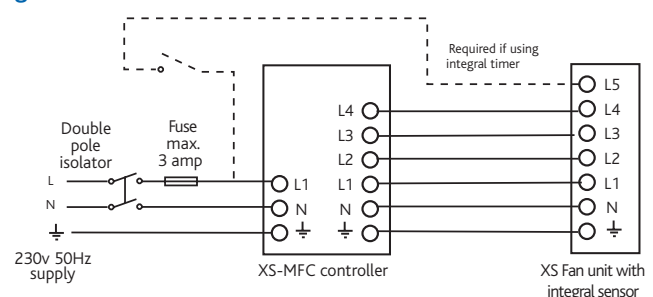

Remote switch may be set: On / Off, Forward / Reverse, Economy / Std. (variable speed), Auto / Manual.

Maximum one Integral Sensor per fan 6/9/12 denotes unit size identity.

Humidity Sensor: XS-H6/9/12, Air Quality Sensor: XS-AQ6/9/12.

Passive Infra Red Sensor: XS-PIR6/9/12, Temperature Sensor: XS-TH6/9/12.

Run on Timer: XS-TA6/9/12.

A single sensor will switch all fans if more than one fan is being operated by a single XS-MFC controller.

WIRING - MULTIPLE FANS

Multiple fans operated via remote XS-MFC control

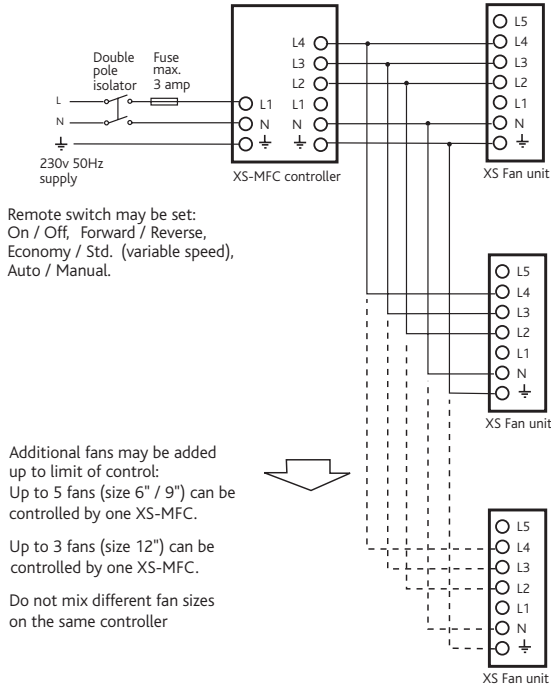

Multiple fans operated via remote XS-MFC control and one
Integral Sensor in Fan 1

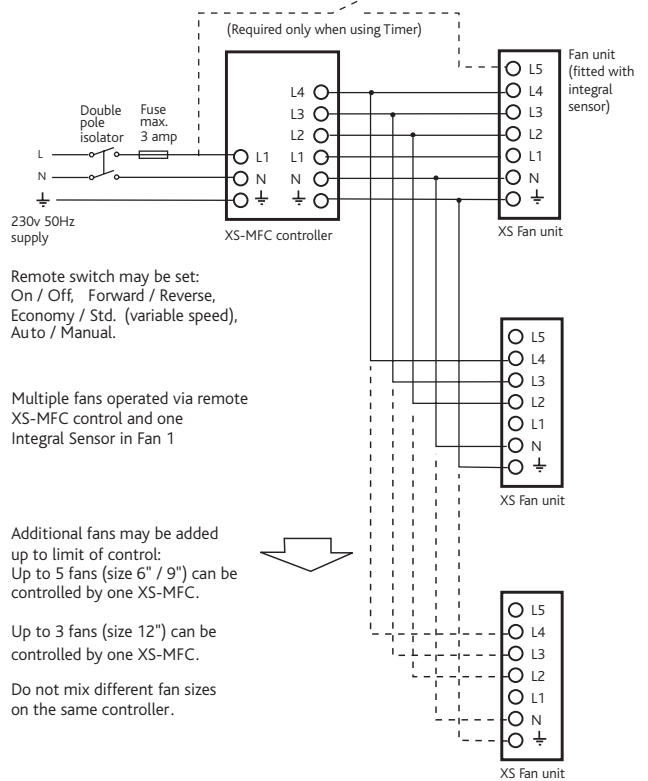

Multiple fans operated via remote XS-MFC control and a
Remote Sensor

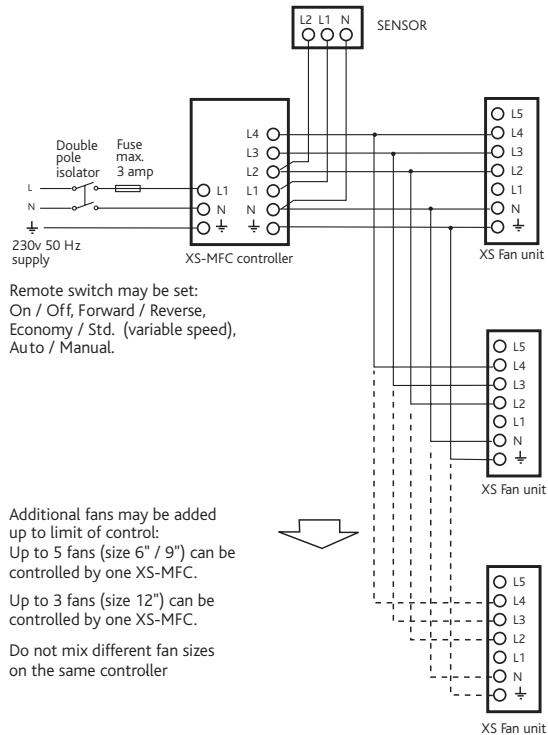

Fan operated using remote XS-MFC control and a Multiple
Remote Sensor

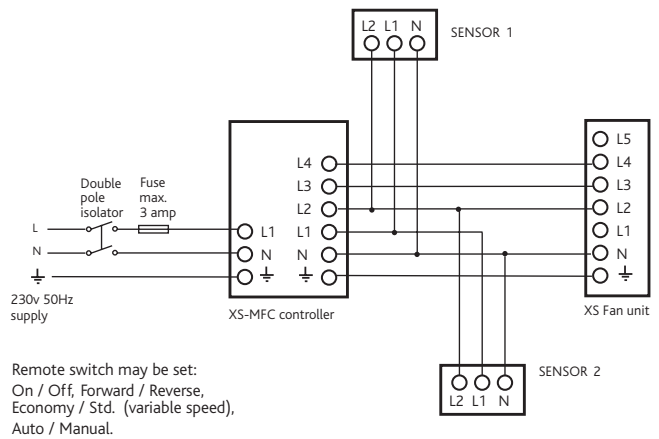

CONSULTANTS SPECIFICATION

FAN DESCRIPTION

The extract fan/s shall be located in the positions indicated on the drawings and in accordance with the relevant fan schedule.

The fan shall be of the XS type and shall be supplied complete with integrated low loss radial backdraught shutter, silent operation via a thermo actuator, room side grille, connection kit and external louvre/roof cowl to suit the particular application.

The high efficiency, low noise axial flow impeller shall be directly driven by an external rotor motor featuring enclosure protection to IP 44, class B winding insulation and maintenance free ball bearings. All models shall be suitable for air over motor temperatures of up to 60°C and 95% R.H (non-condensing).

The motor and impeller shall be dynamically balanced as an assembly.

Fan casing, impeller and shutter shall be manufactured from UV stabilised ABS polymer. All models shall include an economy/high efficiency setting facility and are dove grey in colour.

The fan shall be provided complete with integrated or remote controls as detailed in the schedule and as described below.

Where indicated the fans shall be interlinked and controlled from 1No. controller (up to 5 fans sizes 6 & 9, up to 3 fans size 12).

Fans shall be reversible via reversing switch on XS-MFC fan controller.

Fan to have a manufacturers 3 year warranty.

Fan to be of the XS type as manufactured by Nuaire Ltd.

FAN CONTROL OPTION

The fan shall be provided with either integrated sensor to activate the fan or one of the remote options:

INTEGRATED CONTROL OPTIONS:

- PIR (passive infra-red) movement detector (includes run-on timer), 2-40 mins
- Humidity sensor (includes run-on timer), 30-90% RH - 2-40 mins RT
- Air quality sensor (includes run-on timer), 2-40 mins
- Run-on timer (all adjustable between 2-40 mins)
- Temperature sensor (includes run-on timer), 5-35°C (fixed 2mm overrun)

REMOTE CONTROL OPTIONS:

- PIR (passive infra-red) movement detector (includes run-on timer), 2-40 mins
- Humidity sensor (includes run-on timer), 30-90% RH - 2-40 mins RT
- Air quality sensor (includes run-on timer), 2-40 mins RT
- Anti-tamper security strap.
- XS-MFC controller incorporating economy switch, reversing switch and rotary speed control –

1No. XS-MFC controller may be used to control up to 5 fans.

Fan, integrated controls or associated sensors/controllers shall be as manufactured by Nuaire Ltd all with a 3 years warranty.

The manufacturer's recommendations should be observed at all times.